

Article number: 03004040

Description: Fluro Rod End GAS 40
Zinc Plated

Measures

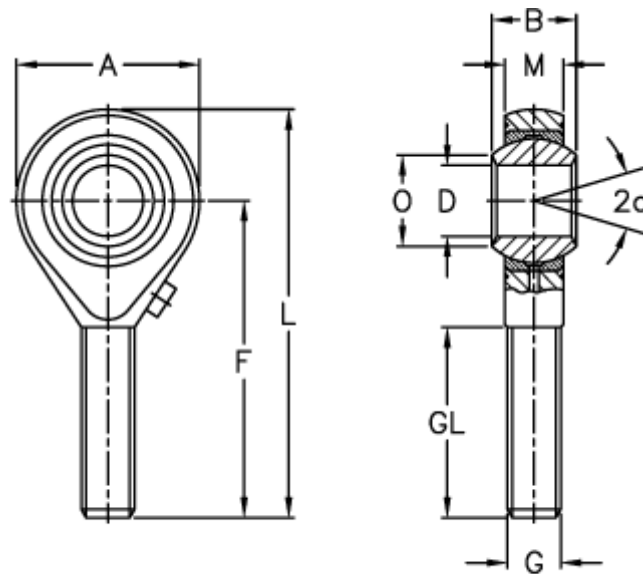

Str. 2-5 uden smørenippel

A	= 90	L	= 187
a (degrees)	= 16	M	= 35
B	= 49	O	= 44.2
D	= 40	Permissible rpm	= 290
Dynamic load C (kN)	= 116	Static load C0 (kN)	= 124
F	= 142	Weight (g)	= 2550
g	= M42x2		
GL	= 78		